

# VS2 Opposed-Mode Sensors

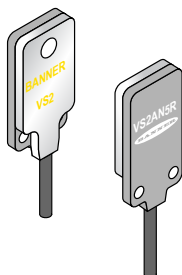

## Datasheet

Miniature Self-Contained Sensors



- Totally self-contained miniature sensors
- 10 V dc to 30 V dc operation
- Visible red or infrared sensing beam, depending on model
- Up to 3 m (118 in) sensing range (see Range specifications)
- Choose dark or light operate models
- Choose models with NPN or PNP output
- 2-wire and 3-wire hookup; output load capacity to 50 mA
- Choice of integral cable or quick-disconnect
- Sensors may be purchased in pairs, or individually



### WARNING: Not To Be Used for Personnel Protection

Never use this device as a sensing device for personnel **protection**. Doing so could lead to serious injury or death. This device does not include the self-checking redundant circuitry necessary to allow its use in personnel safety applications. A sensor failure or malfunction can cause either an energized or de-energized sensor output condition.

## Models

Component	Cabled Models <sup>1</sup>	OD Models <sup>2</sup>	Sensing Beam/ Range	Output Type	Supply Voltage
Emitter	VS25EV	VS25EVQ	Visible red, 660 nm 1.2 m (47 in)	NPN/ Light Operate	10 V dc to 30 V dc
Receiver	VS2AN5R	VS2AN5RQ			
Sensor Pair	VS2KAN5V	VS2KAN5VQ			
Emitter	VS25EV	VS25EVQ		PNP/ Light Operate	
Receiver	VS2AP5R	VS2AP5RQ			
Sensor Pair	VS2KAP5V	VS2KAP5VQ			
Emitter	VS25EV	VS25EVQ		NPN/ Dark Operate	
Receiver	VS2RN5R	VS2RN5RQ			
Sensor Pair	VS2KRN5V	VS2KRN5VQ			
Emitter	VS25EV	VS25EVQ		PNP/ Dark Operate	
Receiver	VS2RP5R	VS2RP5RQ			
Sensor Pair	VS2KRP5V	VS2KRP5VQ			
Emitter	VS25E	VS25EQ	Infrared, 940 nm 3.0 m (118 in)	NPN/ Light Operate	
Receiver	VS2AN5R	VS2AN5RQ			
Sensor Pair	VS2KAN5	VS2KAN5Q			
Emitter	VS25E	VS25EQ		PNP/ Light Operate	
Receiver	VS2AP5R	VS2AP5RQ			
Sensor Pair	VS2KAP5	VS2KAP5Q			
Emitter	VS25E	VS25EQ		NPN/ Dark Operate	
Receiver	VS2RN5R	VS2RN5RQ			
Sensor Pair	VS2KRN5	VS2KRN5Q			
Emitter	VS25E	VS25EQ		PNP/ Dark Operate	
Receiver	VS2RP5R	VS2RP5RQ			
Sensor Pair	VS2KRP5	VS2KRP5Q			

<sup>1</sup> Cabled models have 2 m (6.5 ft) integral cable; 2-wire for emitters, 3-wire for receivers.

<sup>2</sup> OD models have 3-pin 150 mm (6.5 in) Pico-style OD. OD models require mating corset.



## Overview

VS2 Series miniature self-contained sensors are designed for precision sensing in small areas previously accessible only to remote or fiber optic models. Typical applications include mounting inside vibrating feeders and electronic component handling equipment.

## Wiring Diagrams

### Emitters

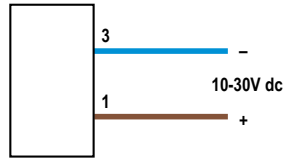

### NPN Models

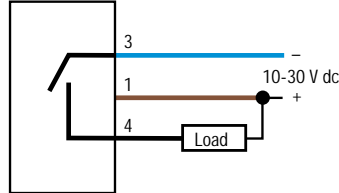

### PNP Models

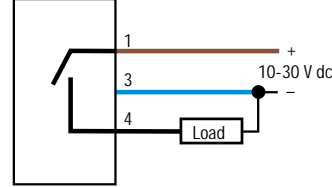

### Key

- 1 = Brown
- 3 = Blue
- 4 = Black

Quick disconnect (QD) wiring diagrams are functionally identical.

## Specifications

### Supply Voltage and Current

- 10 V dc to 30 V dc (10% maximum ripple)
- Emitter:** 25 mA (visible beam); 30 mA (infrared beam)
- Receiver:** 25 mA (exclusive of load)

### Supply Protection Circuitry

Protected against reverse polarity and transient voltages

### Output Configuration

- SPST solid-state switch
- Choose NPN (current sinking) or PNP (current sourcing) models
- Choose light operate (N.O.) or dark operate (N.C.) models

### Output Rating

- 50 mA maximum
- Off-state leakage current: < 1 microamp at 24V dc
- On-state saturation voltage: < 0.25V at 10 mA dc; < 0.5V at 50 mA dc

### Output Protection Circuitry

Protected against output short-circuit, continuous overload, and false pulse on power-up

Overload trip point  $\geq 100$  mA

### Output Response Time

1 millisecond ON and 0.5 milliseconds OFF



Note: 100 millisecond delay on power-up: output is non-conducting during this time

### Repeatability

100 microseconds

### Indicators

- Two LEDs: Green and Amber
- Green ON = power to sensor is ON
- Green flashing = output overload
- Amber ON = light is sensed
- Amber flashing = marginal excess gain (1–1.5 $\times$ ) in light condition

### Construction

Black ABS housing with clear MABS lens

### Connections

2 m (6.5 ft) attached cable: three #28 ga stranded conductors with PE insulation; PVC outer cable jacket; or 3-pin 150 mm (6.5 in) Pico-style quick-disconnect fitting. QD cables are ordered separately.

### Environmental Rating

IEC IP67, NEMA 6

### Operating Conditions

- 20 °C to +55 °C (-4 °F to +131 °F)
- 80% at +50 °C maximum relative humidity (non-condensing)

### Vibration and Mechanical Shock

- Vibration:** All models meet IEC 60068-2-6, IEC 60947-5-2, UL491 Section 40, MIL-STD-202F Method 201A; 10 to 60 Hz, 0.5 mm peak to peak
- Shock:** All models meet IEC 60068-2-27, IEC 60947-5-2; 30g peak acceleration, 11 millisecond pulse duration, half-sine wave pulse shape

### Application Notes

M2 stainless steel mounting hardware included. Optional mounting brackets are available

### Certifications



## Performance Curves

### Excess Gain Curves

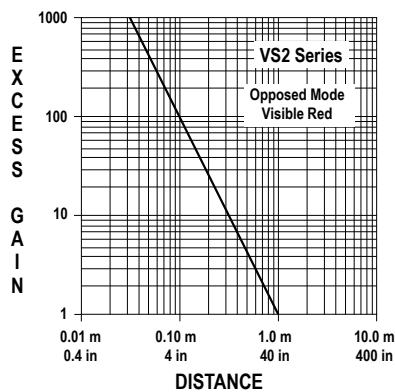

### Beam Patterns

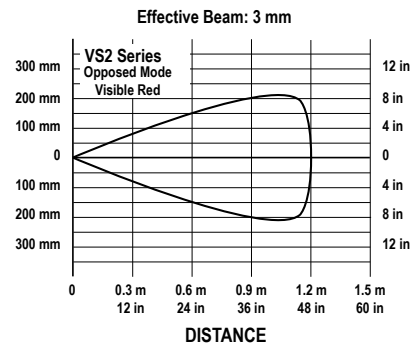

Excess Gain Curves

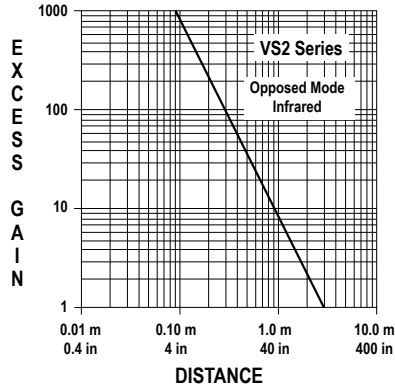

Beam Patterns

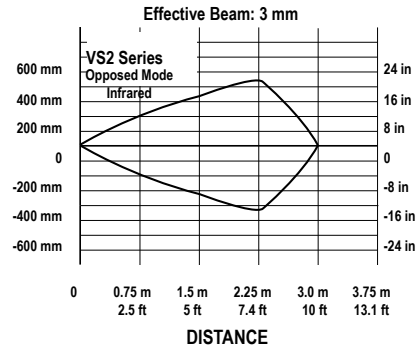

Dimensions

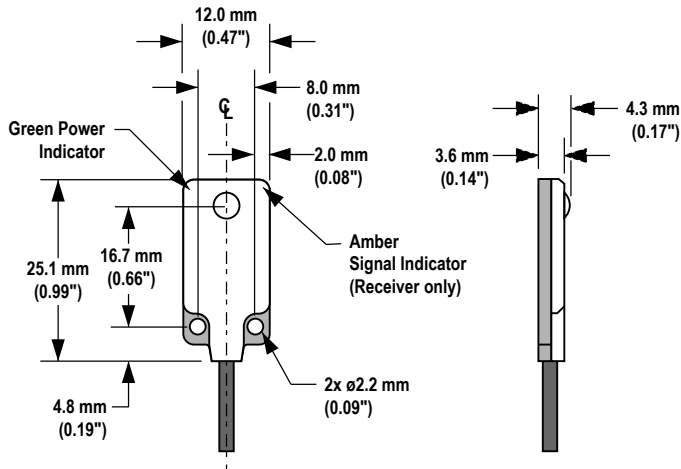

Accessories

Quick-Disconnect Cables

3-Pin Threaded M8/Pico-Style Cordsets				
Model	Length	Style	Dimensions	Pinout (Female)
PKG3M-2	2 m (6.56 ft)	Straight		<p>1 = Brown 3 = Blue 4 = Black</p>
PKG3M-5	5 m (16.40 ft)			
PKG3M-7	7 m (22.97 ft)			
PKG3M-9	9 m (29.53 ft)			
PKG3M-10	10 m (32.81 ft)			

Apertures

All models are • 0.1 mm 300 series stainless steel.

Model	Description	
Circular		
APVS2-0204	Two openings, 0.5 (0.02 in) and 1 mm (0.04 in) diameter	
APVS2-0608	Two openings, 1.5 (0.06 in) and 2.0 (0.08 in) mm diameter	
Horizontal and Vertical Slot		
APVS2-02R	One each, 0.5 mm (0.02 in) wide	
APVS2-04R	One each, 1.0 mm (0.04 in) wide	

## Brackets

### SMBVS2RA

- Right-angle bracket
- Stainless steel

Hole center spacing: A = 80.0

Hole size: A = 3.2 x 6.0

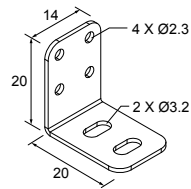

## Banner Engineering Corp. Limited Warranty

Banner Engineering Corp. warrants its products to be free from defects in material and workmanship for one year following the date of shipment. Banner Engineering Corp. will repair or replace, free of charge, any product of its manufacture which, at the time it is returned to the factory, is found to have been defective during the warranty period. This warranty does not cover damage or liability for misuse, abuse, or the improper application or installation of the Banner product.

THIS LIMITED WARRANTY IS EXCLUSIVE AND IN LIEU OF ALL OTHER WARRANTIES WHETHER EXPRESS OR IMPLIED (INCLUDING, WITHOUT LIMITATION, ANY WARRANTY OF MERCHANTABILITY OR FITNESS FOR A PARTICULAR PURPOSE), AND WHETHER ARISING UNDER COURSE OF PERFORMANCE, COURSE OF DEALING OR TRADE USAGE.

This Warranty is exclusive and limited to repair or, at the discretion of Banner Engineering Corp., replacement. IN NO EVENT SHALL BANNER ENGINEERING CORP. BE LIABLE TO BUYER OR ANY OTHER PERSON OR ENTITY FOR ANY EXTRA COSTS, EXPENSES, LOSSES, LOSS OF PROFITS, OR ANY INCIDENTAL, CONSEQUENTIAL OR SPECIAL DAMAGES RESULTING FROM ANY PRODUCT DEFECT OR FROM THE USE OR INABILITY TO USE THE PRODUCT, WHETHER ARISING IN CONTRACT OR WARRANTY, STATUTE, TORT, STRICT LIABILITY, NEGLIGENCE, OR OTHERWISE.

Banner Engineering Corp. reserves the right to change, modify or improve the design of the product without assuming any obligations or liabilities relating to any product previously manufactured by Banner Engineering Corp. Any misuse, abuse, or improper application or installation of this product or use of the product for personal protection applications when the product is identified as not intended for such purposes will void the product warranty. Any modifications to this product without prior express approval by Banner Engineering Corp will void the product warranties. All specifications published in this document are subject to change; Banner reserves the right to modify product specifications or update documentation at any time. Specifications and product information in English supersede that which is provided in any other language. For the most recent version of any documentation, refer to: [www.bannerengineering.com](http://www.bannerengineering.com).